

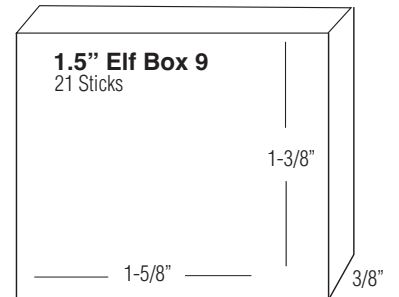

Price Book 2025

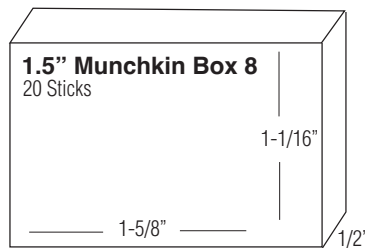
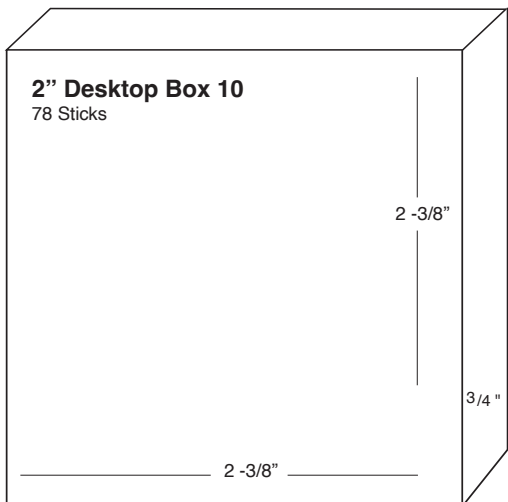
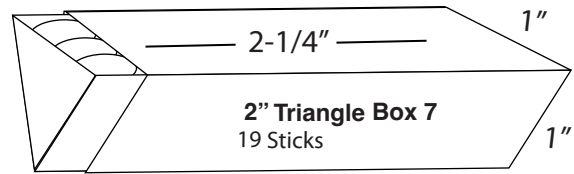
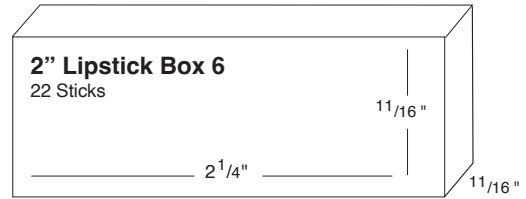
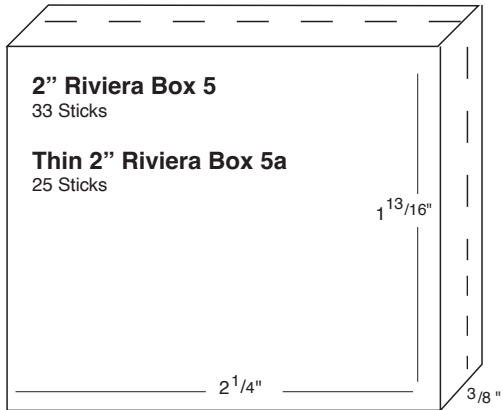
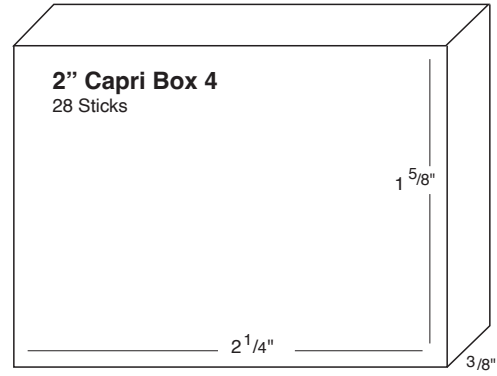
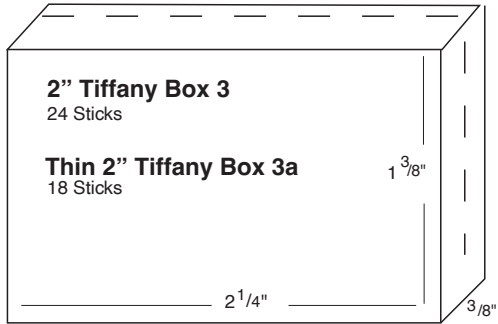
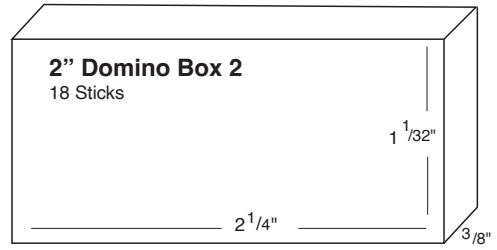
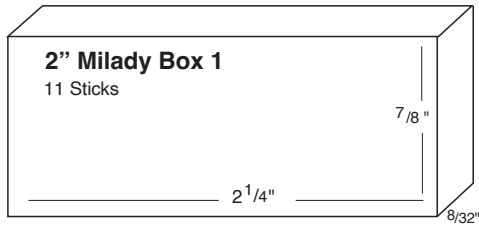

Standard Match Boxes - Pricing

Pricing includes full bleed imprinting on the entire outside cover and UV gloss coating with your choice of 17 match tip colors. Art and plate charges will be assessed on all first time orders. Please allow 9 - 12 weeks for delivery. Expedited airfreight is available.



Milady 2" - Box 1	5,000	10,000	25,000	50,000	100,000
1 Color	\$1,050.00	\$1,580.00	\$3,180.00	\$5,240.00	\$8,040.00
Cost per box	\$0.21	\$0.16	\$0.13	\$0.10	\$0.08
2 Colors	\$1,160.00	\$1,740.00	\$3,380.00	\$5,520.00	\$8,420.00
Cost per box	\$0.23	\$0.17	\$0.14	\$0.11	\$0.08
3 Colors	\$1,270.00	\$1,900.00	\$3,580.00	\$5,800.00	\$8,800.00
Cost per boxe	\$0.25	\$0.19	\$0.14	\$0.12	\$0.09
4 colors	\$1,380.00	\$2,060.00	\$3,780.00	\$6,080.00	\$9,180.00
Cost per box	\$0.28	\$0.21	\$0.15	\$0.12	\$0.09

Domino 2" - Box 2	5,000	10,000	25,000	50,000	100,000
1 Color	\$1,200.00	\$1,970.00	\$3,970.00	\$6,390.00	\$9,500.00
Cost per box	\$0.24	\$0.20	\$0.16	\$0.13	\$0.10
2 Colors	\$1,305.00	\$2,140.00	\$4,190.00	\$6,680.00	\$9,900.00
Cost per box	\$0.26	\$0.21	\$0.17	\$0.13	\$0.10
3 Colors	\$1,410.00	\$2,310.00	\$4,410.00	\$6,970.00	\$10,300.00
Cost per box	\$0.28	\$0.23	\$0.18	\$0.14	\$0.10
4 Colors	\$1,515.00	\$2,480.00	\$4,630.00	\$7,260.00	\$10,700.00
Cost per box	\$0.30	\$0.25	\$0.19	\$0.15	\$0.11

Tiffany 2" Thin & Tiffany 2" - Box 3	5,000	10,000	25,000	50,000	100,000
1 Color	\$1,240.00	\$1,910.00	\$3,380.00	\$5,480.00	\$8,420.00
Cost per box	\$0.25	\$0.19	\$0.14	\$0.11	\$0.08
2 Colors	\$1,345.00	\$2,070.00	\$3,580.00	\$5,760.00	\$8,780.00
Cost per box	\$0.27	\$0.21	\$0.14	\$0.12	\$0.09
3 Colors	\$1,450.00	\$2,230.00	\$3,780.00	\$6,040.00	\$9,140.00
Cost per box	\$0.29	\$0.22	\$0.15	\$0.12	\$0.09
4 Colors	\$1,555.00	\$2,390.00	\$3,980.00	\$6,320.00	\$9,500.00
Cost per box	\$0.31	\$0.24	\$0.16	\$0.13	\$0.10

Standard Matchboxes - Pricing

Pricing includes full bleed imprinting on the entire outside cover and UV gloss coating with your choice of 17 match tip colors. Art and plate charges will be assessed on all first time orders. Please allow 9 - 12 weeks for delivery. Expedited airfreight is available.



Capri 2" Box 4	5,000	10,000	25,000	50,000	100,000
1 Color	\$1,490.00	\$2,490.00	\$5,040.00	\$8,100.00	\$12,260.00
Cost per box	\$0.30	\$0.25	\$0.20	\$0.16	\$0.12
2 Colors	\$1,595.00	\$2,660.00	\$5,260.00	\$8,400.00	\$12,660.00
Cost per box	\$0.32	\$0.27	\$0.21	\$0.17	\$0.13
3 Colors	\$1,700.00	\$2,830.00	\$5,480.00	\$8,700.00	\$13,060.00
Cost per box	\$0.34	\$0.28	\$0.22	\$0.17	\$0.13
4 Colors	\$1,805.00	\$3,000.00	\$5,700.00	\$9,000.00	\$13,460.00
Cost per box	\$0.36	\$0.30	\$0.23	\$0.18	\$0.13

Riviera 2" Thin & Riviera 2" Box 5	5,000	10,000	25,000	50,000	100,000
1 Color	\$1,660.00	\$2,790.00	\$5,620.00	\$9,160.00	\$14,100.00
Cost per box	\$0.33	\$0.28	\$0.22	\$0.18	\$0.14
2 Colors	\$1,765.00	\$2,960.00	\$5,830.00	\$9,450.00	\$14,500.00
Cost per box	\$0.355	\$0.30	\$0.23	\$0.19	\$0.15
3 Colors	\$1,870.00	\$3,130.00	\$6,040.00	\$9,740.00	\$14,900.00
Cost per box	\$0.37	\$0.31	\$0.24	\$0.19	\$0.15
4 Colors	\$1,875.00	\$3,300.00	\$6,250.00	\$10,030.00	\$15,300.00
Cost per box	\$0.38	\$0.33	\$0.25	\$0.20	\$0.15

Lipstick 2" Box 6	5,000	10,000	25,000	50,000	100,000
1 Color	\$1,645.00	\$2,620.00	\$5,040.00	\$8,200.00	\$11,940.00
Cost per box	\$0.33	\$0.26	\$0.20	\$0.16	\$0.12
2 Colors	\$1,760.00	\$2,775.00	\$5,240.00	\$8,475.00	\$12,320.00
Cost per box	\$0.35	\$0.28	\$0.21	\$0.17	\$0.12
3 Colors	\$1,875.00	\$2,930.00	\$5,440.00	\$8,750.00	\$12,700.00
Cost per box	\$0.38	\$0.29	\$0.22	\$0.18	\$0.13
4 Colors	\$1,990.00	\$3,085.00	\$5,640.00	\$9,025.00	\$13,080.00
Cost per box	\$0.40	\$0.31	\$0.23	\$0.18	\$0.13

Standard Match Boxes - Pricing

Pricing includes full bleed imprinting on the entire outside cover and UV gloss coating with your choice of 17 match tip colors. Art and plate charges will be assessed on all first time orders. Please allow 9 - 12 weeks for delivery. Expedited airfreight is available.

Triangle 2" Box 7	5,000	10,000	20,000	30,000	50,000
1 Color	\$1,680.00	\$2,720.00	\$4,360.00	\$5,520.00	\$7,730.00
Cost per box	\$0.34	\$0.27	\$0.22	\$0.18	\$0.15
2 Colors	\$1,800.00	\$2,880.00	\$4,535.00	\$5,710.00	\$7,990.00
Cost per box	\$0.36	\$0.29	\$0.23	\$0.19	\$0.16
3 Colors	\$1,920.00	\$3,040.00	\$4,710.00	\$5,900.00	\$8,250.00
Cost per box	\$0.38	\$0.30	\$0.24	\$0.20	\$0.17
4 Colors	\$2,040.00	\$3,200.00	\$4,885.00	\$6,090.00	\$8,510.00
Cost per box	\$0.41	\$0.32	\$0.24	\$0.20	\$0.17

Elf & Munchkin 1.5" Box 8	5,000	10,000	25,000	50,000	100,000
1 Color	\$1,565.00	\$2,545.00	\$4,770.00	\$8,270.00	\$14,200.00
Cost per box	\$0.31	\$0.25	\$0.19	\$0.17	\$0.14
2 Colors	\$1,690.00	\$2,710.00	\$4,990.00	\$8,570.00	\$14,600.00
Cost per box	\$0.34	\$0.27	\$0.20	\$0.17	\$0.14
3 Colors	\$1,815.00	\$2,875.00	\$5,210.00	\$8,870.00	\$15,000.00
Cost per box	\$0.36	\$0.29	\$0.21	\$0.18	\$0.15
4 Colors	\$1,940.00	\$3,040.00	\$5,430.00	\$9,170.00	\$15,400.00
Cost per box	\$0.39	\$0.30	\$0.22	\$0.18	\$0.15

Desktop 2" Box 10	1,000	2,500	5,000	10,000	25,000
1 Color	\$1,000.00	\$2,000.00	\$3,600.00	\$5,600.00	\$10,500.00
Cost per box	\$1.00	\$0.80	\$0.72	\$0.56	\$0.42
2 Colors	\$1,100.00	\$2,200.00	\$3,900.00	\$5,900.00	\$11,000.00
Cost per box	\$1.10	\$0.88	\$0.78	\$0.59	\$0.44
3 Colors	\$1,200.00	\$2,400.00	\$4,200.00	\$6,200.00	\$11,500.00
Cost per box	\$1.20	\$0.96	\$0.84	\$0.62	\$0.46
4 Colors	\$1,300.00	\$2,600.00	\$4,500.00	\$6,500.00	\$12,000.00
Cost per box	\$1.30	\$1.04	\$0.90	\$0.65	\$0.48

Standard Match Boxes - Specialty Options

Art and plate charges will be assessed on all first time orders. Please allow 9 - 12 weeks for delivery. Expedited airfreight is available. 16 tip colors available on all standard boxes.



Call for pricing on the Desktop 2" - Box 10 specialty options.

Specialty Options	5,000	10,000	25,000	50,000	100,000
Add Matte Varnish (outside only)	\$195.00	\$285.00	\$425.00	\$640.00	\$900.00
Add Spot Shiny Varnish (outside only)	\$80.00	\$145.00	\$270.00	\$410.00	\$450.00
KRAFT BOARDSTOCK UPGRADE	\$55.00	\$110.00	\$275.00	\$1,500.00	\$3,000.00
Add FOIL Hotstamping*	\$280.00	\$560.00	\$1,400.00	\$2,800.00	\$5,600.00
Add DIE Embossing*	\$190.00	\$380.00	\$950.00	\$1,900.00	\$3,800.00
Color Match Sticks	\$165.00	\$330.00	\$825.00	\$1,650.00	\$3,300.00
Mixed Tip Colors (up-to 3 stock colors)	\$100.00	\$200.00	\$500.00	\$1,000.00	\$2,000.00
Add Drawer Color	\$145.00	\$290.00	\$725.00	\$1,450.00	\$2,900.00
Custom Tip Color (approx. PMS)	\$200.00	\$200.00	\$0.00	\$0.00	\$0.00
Riviera FOIL Hotstamping*	\$420.00	\$840.00	\$2,100.00	\$4,200.00	\$8,400.00
Riviera DIE Embossing*	\$285.00	\$570.00	\$1,425.00	\$2,850.00	\$5,700.00
*\$230 one time plate fee					

12 Light Mini Book

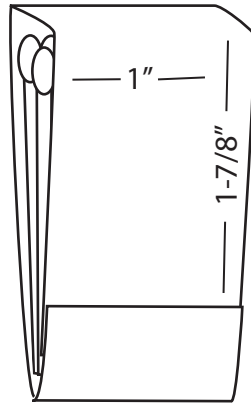

20 Light Book

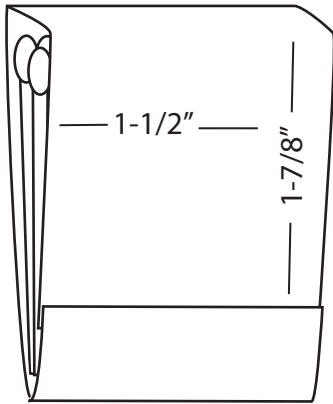

24 Light Book

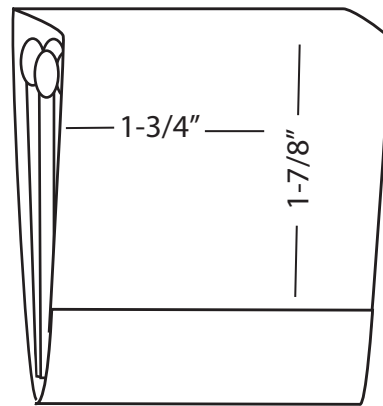

30 Light Book

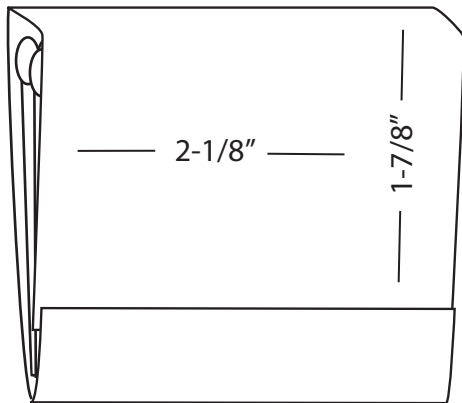

40 Light Book

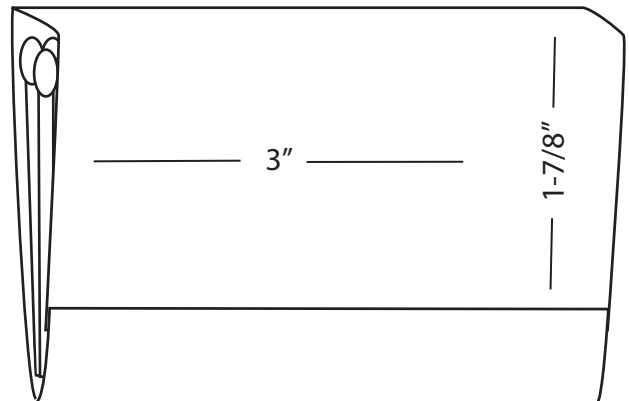

Standard Matchbooks - Pricing

Pricing includes full bleed imprinting on the entire outside cover and UV gloss coating.

Art and plate charges will be assessed on all first time orders. Please allow 9 - 12 weeks for delivery. Expedited airfreight is available.

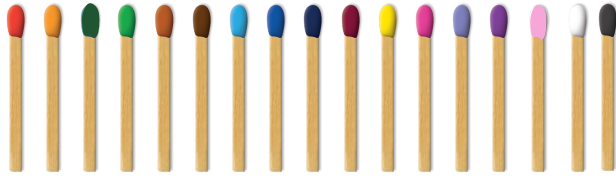

20-Light Book	5,000	10,000	25,000	50,000	100,000
1 Color	\$720.00	\$1,110.00	\$1,925.00	\$3,290.00	\$5,240.00
Cost per book	\$0.14	\$0.11	\$0.08	\$0.07	\$0.05
2 Colors	\$840.00	\$1,340.00	\$2,275.00	\$3,820.00	\$5,850.00
Cost per book	\$0.17	\$0.13	\$0.09	\$0.08	\$0.06
3 Colors	\$960.00	\$1,570.00	\$2,625.00	\$4,350.00	\$6,460.00
Cost per book	\$0.19	\$0.16	\$0.11	\$0.09	\$0.06
4 Colors	\$1,080.00	\$1,800.00	\$2,975.00	4,880.00	\$7,070.00
Cost per book	\$0.22	\$0.18	\$0.12	\$0.10	\$0.07

30-Light Book	5,000	10,000	25,000	50,000	100,000
1 Color	\$930.00	\$1,530.00	\$2,560.00	\$4,680.00	\$8,010.00
Cost per book	\$0.19	\$0.15	\$0.10	\$0.09	\$0.08
2 Colors	\$1,050.00	\$1,760.00	\$2,910.00	\$5,220.00	\$8,640.00
Cost per book	\$0.21	\$0.18	\$0.12	\$0.10	\$0.09
3 Colors	\$1,170.00	\$1,990.00	\$3,260.00	\$5,760.00	\$9,250.00
Cost per book	\$0.23	\$0.20	\$0.13	\$0.12	\$0.09
4 Colors	\$1,290.00	\$2,220.00	\$3,610.00	\$6,300.00	\$9,880.00
Cost per book	\$0.26	\$0.22	\$0.14	\$0.13	\$0.10

40-Light Book	5,000	10,000	25,000	50,000	100,000
1 Color	\$1,080.00	\$1,800.00	\$2,730.00	\$4,050.00	\$8,440.00
Cost per book	\$0.22	\$0.18	\$0.11	\$0.08	\$0.08
2 Colors	\$1,250.00	\$2,100.00	\$3,190.00	\$4,640.00	\$9,270.00
Cost per book	\$0.25	\$0.21	\$0.13	\$0.09	\$0.09
3 Colors	\$1,420.00	\$2,400.00	\$3,650.00	\$5,230.00	\$10,100.00
Cost per book	\$0.28	\$0.23	\$0.14	\$0.10	\$0.10
4 Colors	\$1,590.00	\$2,700.00	\$4,100.00	\$5,820.00	\$10,390.00
Cost per book	\$0.32	\$0.27	\$0.16	\$0.12	\$0.10

Standard Match Books - Pricing

Pricing includes full bleed imprinting on the entire outside cover and UV gloss coating.

Art and plate charges will be assessed on all first time orders. Please allow 9 - 12 weeks for delivery. Expedited airfreight is available.

Mini 12-Light Book	5,000	10,000	25,000	50,000	100,000
1 Color	\$1,030.00	\$1,880.00	\$3,725.00	\$6,780.00	\$11,100.00
Cost per book	\$0.21	\$0.19	\$0.15	\$0.14	\$0.11
2 Colors	\$1,160.00	\$2,120.00	\$4,100.00	\$7,340.00	\$11,750.00
Cost per book	\$0.23	\$0.21	\$0.16	\$0.15	\$0.12
3 Colors	\$1,290.00	\$2,360.00	\$4,475.00	\$7,900.00	\$12,400.00
Cost per book	\$0.26	\$0.24	\$0.18	\$0.16	\$0.12
4 Colors	\$1,420.00	\$2,600.00	\$4,850.00	\$8,460.00	\$13,050.00
Cost per book	\$0.28	\$0.26	\$0.19	\$0.17	\$0.13

24-Light Book	5,000	10,000	25,000	50,000	100,000
1 Color	\$1,030.00	\$1,780.00	\$3,820.00	\$6,940.00	\$10,720.00
Cost per book	\$0.21	\$0.18	\$0.15	\$0.14	\$0.11
2 Colors	\$1,150.00	\$2,000.00	\$4,180.00	\$7,480.00	\$11,360.00
Cost per book	\$0.23	\$0.20	\$0.17	\$0.15	\$0.11
3 Colors	\$1,270.00	\$2,220.00	\$4,540.00	\$8,020.00	\$12,000.00
Cost per book	\$0.25	\$0.22	\$0.18	\$0.16	\$0.12
4 Colors	\$1,390.00	\$2,440.00	\$4,900.00	\$8,560.00	\$12,640.00
Cost per book	\$0.28	\$0.24	\$0.20	\$0.17	\$0.13

Specialty Options	5,000	10,000	25,000	50,000	100,000
Inside Print Per Color	\$80.00	\$145.00	\$270.00	\$410.00	\$540.00
Add Matte Varnish (outside only)	\$160.00	\$295.00	\$550.00	\$825.00	\$1,080.00
Add Spot Shiny Varnish (outside only)	\$80.00	\$145.00	\$270.00	\$410.00	\$540.00
KRAFT BOARDSTOCK UPGRADE	\$45.00	\$90.00	\$225.00	\$450.00	\$900.00
Add FOIL Hotstamping*	\$255.00	\$510.00	\$1,275.00	\$2,555.00	\$5,100.00
Add DIE Embossing*	\$175.00	\$350.00	\$875.00	\$1,755.00	\$3,500.00
Custom Tip Color (approx. PMS)	\$200.00	\$200.00	\$0.00	\$0.00	\$0.00
*\$230 one time plate fee					

Quick Print/Short Run Matches - Pricing

Price includes up to full color digital printing on the outer cover, one or two sides. Art charges will be assessed on all first time orders. A \$35.00 per side, set up fee will be assessed on all orders. Please allow 6 - 10 days for delivery after final art approval. Quantities over 600 boxes require extended production time. Only white tips available. Note: This product does not print with a full bleed.

Quick Run 2" Tiffany	200	400	500	600	800	1,000
1 Side Cost per Order	\$2.10 \$420.00	\$1.96 \$785.00	\$1.94 \$970.00	\$1.90 \$1,140.00	\$1.86 \$1,490.00	\$1.85 \$1,845.00
Add for 2nd Side Cost for 2-Sides	\$0.53 \$525.00	\$0.38 \$935.00	\$0.30 \$1,120.00	\$0.28 \$1,310.00	\$0.27 \$1,705.00	\$0.26 \$2,105.00

Quick Run 3" Tiffany	200	400	500	600	800	1,000
1 Side Cost per Order	\$3.33 \$665.00	\$3.21 \$1,285.00	\$3.12 \$1,560.00	\$3.03 \$1,815.00	\$2.94 \$2,350.00	\$2.83 \$2,830.00
Add for 2nd Side Cost for 2-Sides	\$0.60 \$785.00	\$0.51 \$1,490.00	\$0.50 \$1,810.00	\$0.49 \$2,110.00	\$0.48 \$2,735.00	\$0.47 \$3,300.00

Quick Run 3" Domino	200	400	500	600	800	1,000
1 Side Cost per Order	\$3.10 \$620.00	\$2.94 \$1,175.00	\$2.83 \$1,415.00	\$2.73 \$1,635.00	\$2.63 \$2,100.00	\$2.54 \$2,535.00
Add for 2nd Side Cost for 2-Sides	\$0.63 \$745.00	\$0.50 \$1,375.00	\$0.49 \$1,660.00	\$0.48 \$1,920.00	\$0.47 \$2,475.00	\$0.46 \$2,995.00

Plain Matchboxes	1 Case	5+ Cases	10+ Cases
Tiffany 2"	\$450.00	\$400.00	\$350.00
Cost per box	\$0.18	\$0.16	\$0.14
Domino 3"	\$375.00	\$325.00	\$275.00
Cost per box	\$0.30	\$0.26	\$0.22
Tiffany 3"	\$400.00	\$350.00	\$300.00
Cost per box	\$0.32	\$0.28	\$0.24

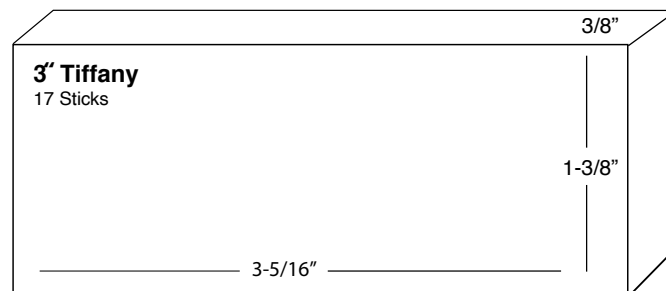
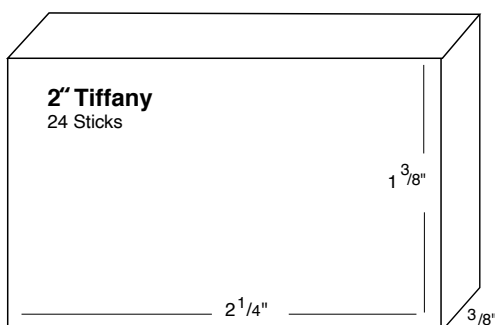
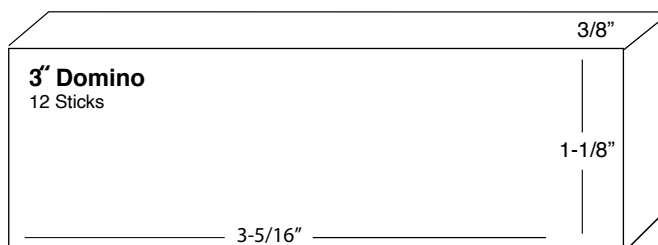

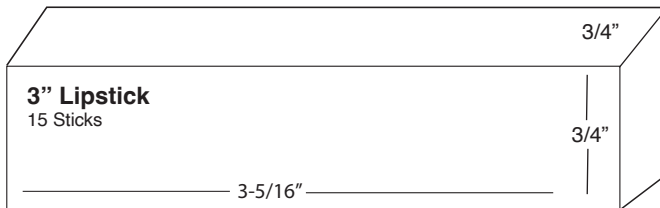
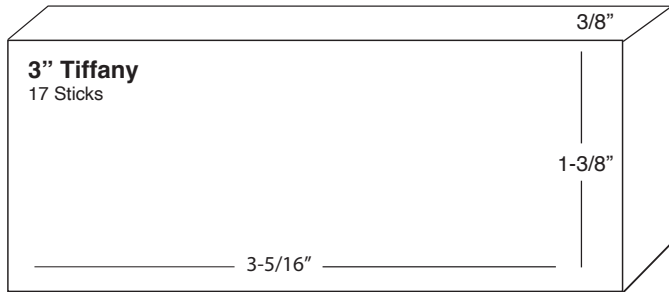
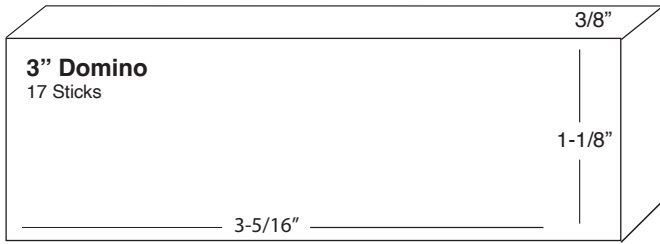

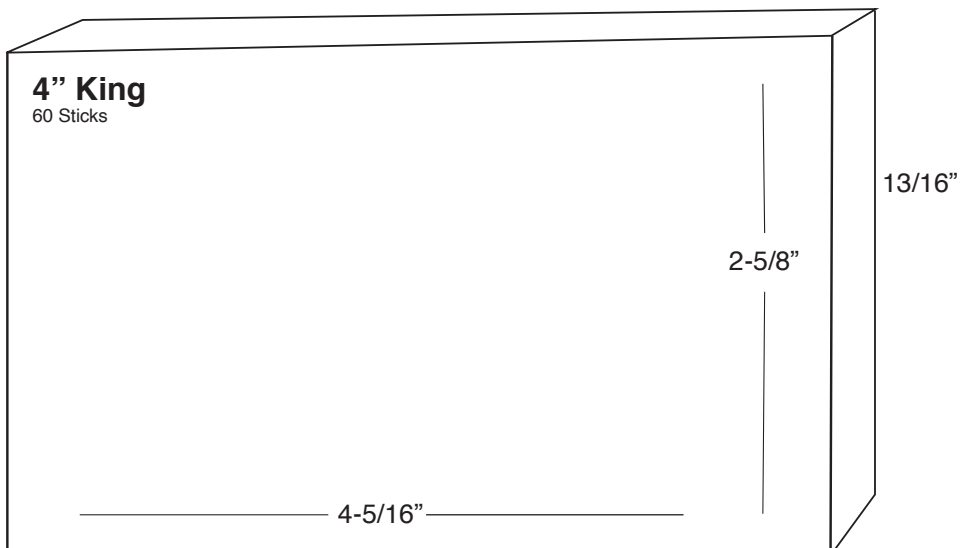
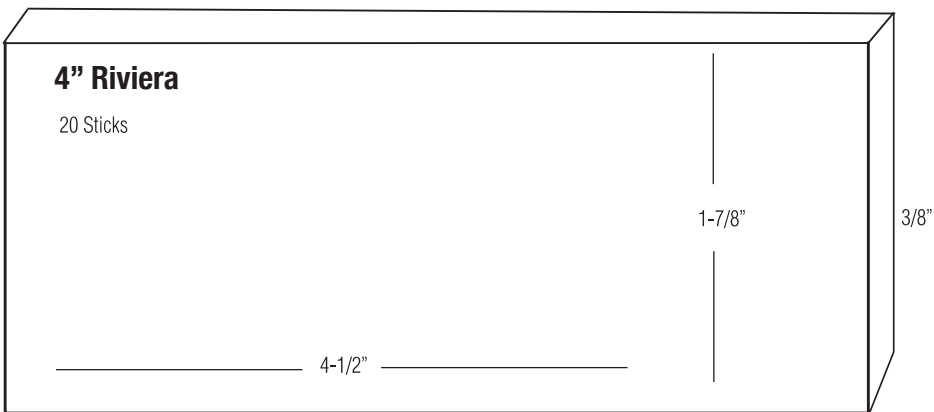
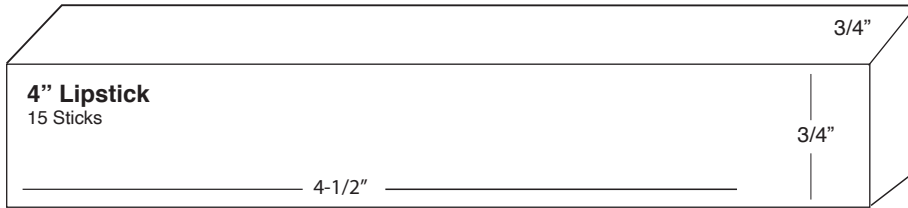
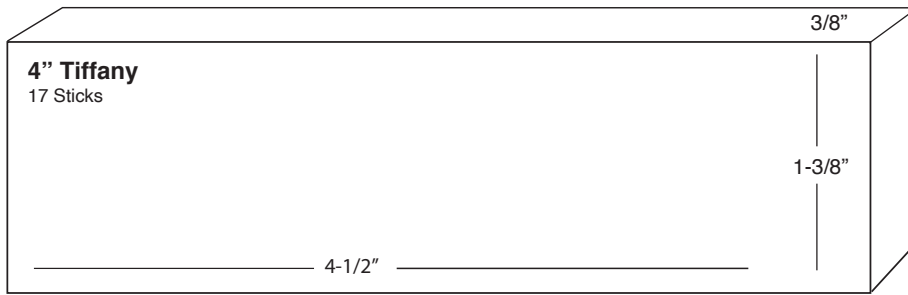

4" Double King not shown.

Candle Matchboxes - Pricing

Art and plate charges will be assessed on all first time orders. Please allow 9 - 12 weeks for delivery.
 Expedited airfreight is available. 17 tip colors available on all standard boxes. Call for pricing on speciality options.

3" Domino	1,000	2,500	5,000	10,000	20,000
1 color Per Unit Price	\$925.00 \$0.93	\$1,370.00 \$0.55	\$2,180.00 \$0.44	\$3,280.00 \$0.33	\$5,910.00 \$0.30
2 colors Per Unit Price	\$995.00 \$1.00	\$1,500.00 \$0.60	\$2,310.00 \$0.46	\$3,470.00 \$0.35	\$6,130.00 \$0.31
3 colors Per Unit Price	\$1,065.00 \$1.07	\$1,630.00 \$0.65	\$2,440.00 \$0.49	\$3,660.00 \$0.37	\$6,350.00 \$0.32
4 color process Per Unit Price	\$1,135.00 \$1.14	\$1,760.00 \$0.70	\$2,570.00 \$0.51	\$3,850.00 \$0.39	\$6,570.00 \$0.33

3" Tiffany	1,000	2,500	5,000	10,000	20,000
1 color Per Unit Price	\$1,050.00 \$1.05	\$1,490.00 \$0.60	\$2,380.00 \$0.48	\$3,600.00 \$0.36	\$6,450.00 \$0.32
2 colors Per Unit Price	\$1,120.00 \$1.12	\$1,620.00 \$0.65	\$2,530.00 \$0.51	\$3,780.00 \$0.38	\$6,670.00 \$0.33
3 colors Per Unit Price	\$1,190.00 \$1.19	\$1,750.00 \$0.70	\$2,680.00 \$0.54	\$3,960.00 \$0.40	\$6,890.00 \$0.34
4 color process Per Unit Price	\$1,260.00 \$1.26	\$1,880.00 \$0.75	\$2,830.00 \$0.57	\$4,140.00 \$0.41	\$7,110.00 \$0.36

3" Lipstick	1,000	2,500	5,000	10,000	20,000
1 color Per Unit Price	\$980.00 \$0.98	\$1,870.00 \$0.75	\$3,010.00 \$0.60	\$4,680.00 \$0.47	\$8,080.00 \$0.40
2 colors Per Unit Price	\$1,050.00 \$1.05	\$1,990.00 \$0.80	\$3,150.00 \$0.63	\$4,860.00 \$0.49	\$8,310.00 \$0.42
3 colors Per Unit Price	\$1,120.00 \$1.12	\$2,110.00 \$0.84	\$3,290.00 \$0.66	\$5,040.00 \$0.50	\$8,540.00 \$0.43
4 color process Per Unit Price	\$1,190.00 \$1.19	\$2,230.00 \$0.89	\$3,430.00 \$0.69	\$5,220.00 \$0.52	\$8,770.00 \$0.44

Candle Matchboxes - Pricing

Art and plate charges will be assessed on all first time orders. Please allow 9 - 12 weeks for delivery. Expedited airfreight is available. 17 tip colors available on all standard boxes. Call for pricing on speciality options.

4" Tiffany	1,000	2,500	5,000	10,000	20,000
1 color Per Unit Price	\$1,200.00 \$1.20	\$2,000.00 \$0.80	\$3,330.00 \$0.67	\$4,800.00 \$0.48	\$8,640.00 \$0.43
2 colors Per Unit Price	\$1,280.00 \$1.28	\$2,130.00 \$0.85	\$3,480.00 \$0.70	\$5,000.00 \$0.50	\$8,880.00 \$0.44
3 colors Per Unit Price	\$1,360.00 \$1.36	\$2,260.00 \$0.90	\$3,630.00 \$0.73	\$5,200.00 \$0.52	\$9,120.00 \$0.46
4 color process Per Unit Price	\$1,440.00 \$1.44	\$2,390.00 \$0.96	\$3,780.00 \$0.76	\$5,400.00 \$0.54	\$9,360.00 \$0.47

4" Lipstick	1,000	2,500	5,000	10,000	20,000
1 color Per Unit Price	\$1,300.00 \$1.30	\$2,500.00 \$1.00	\$3,980.00 \$0.80	\$6,270.00 \$0.63	\$10,870.00 \$0.54
2 colors Per Unit Price	\$1,380.00 \$1.38	\$2,630.00 \$1.05	\$4,130.00 \$0.83	\$6,470.00 \$0.65	\$11,110.00 \$0.56
3 colors Per Unit Price	\$1,460.00 \$1.46	\$2,760.00 \$1.10	\$4,280.00 \$0.86	\$6,670.00 \$0.67	\$11,350.00 \$0.57
4 color process Per Unit Price	\$1,540.00 \$1.54	\$2,890.00 \$1.16	\$4,430.00 \$0.89	\$6,870.00 \$0.69	\$11,590.00 \$0.58

4" Riviera	1,000	2,500	5,000	10,000	25,000
1 color Per Unit Price	\$1,435.00 \$1.44	\$2,400.00 \$0.96	\$3,500.00 \$0.70	\$5,280.00 \$0.53	\$11,335.00 \$0.45
2 colors Per Unit Price	\$1,530.00 \$1.53	\$2,560.00 \$1.02	\$3,680.00 \$0.74	\$5,500.00 \$0.55	\$11,650.00 \$0.47
3 colors Per Unit Price	\$1,625.00 \$1.63	\$2,720.00 \$1.09	\$3,860.00 \$0.77	\$5,720.00 \$0.57	\$11,965.00 \$0.48
4 color process Per Unit Price	\$1,720.00 \$1.72	\$2,880.00 \$1.15	\$4,040.00 \$0.81	\$5,940.00 \$0.59	\$12,280.00 \$0.49

Candle Matchboxes - Pricing

Art and plate charges will be assessed on all first time orders. Please allow 9 - 12 weeks for delivery.
 Expedited airfreight is available. 17 tip colors available on all standard boxes. Call for pricing on speciality options.

4" King	1,000	2,500	5,000	10,000	25,000
1 color Per Unit Price	\$2,005.00 \$2.01	\$3,840.00 \$1.54	\$6,140.00 \$1.23	\$9,200.00 \$0.92	\$20,720.00 \$0.83
2 colors Per Unit Price	\$2,150.00 \$2.15	\$4,140.00 \$1.66	\$6,540.00 \$1.31	\$9,680.00 \$0.97	\$21,340.00 \$0.85
3 colors Per Unit Price	\$2,295.00 \$2.30	\$4,440.00 \$1.78	\$6,940.00 \$1.39	\$10,160.00 \$1.02	\$21,960.00 \$0.88
4 color process Per Unit Price	\$2,440.00 \$2.44	\$4,740.00 \$1.90	\$7,340.00 \$1.47	\$10,640.00 \$1.06	\$22,580.00 \$0.90

4" Double Width King	1,000	2,500	5,000	10,000	
1 color Per Unit Price	\$4,990.00 \$4.99	\$9,090.00 \$3.64	\$15,230.00 \$3.05	\$22,710.00 \$2.27	
2 colors Per Unit Price	\$5,350.00 \$5.35	\$9,810.00 \$3.92	\$16,230.00 \$3.25	\$23,890.00 \$2.39	
3 colors Per Unit Price	\$5,710.00 \$5.71	\$10,530.00 \$4.21	\$17,230.00 \$3.45	\$25,070.00 \$2.51	
4 color process Per Unit Price	\$6,070.00 \$6.07	\$11,250.00 \$4.50	\$18,230.00 \$3.65	\$26,250.00 \$2.63	

4" Drum Cylinder

14 Sticks

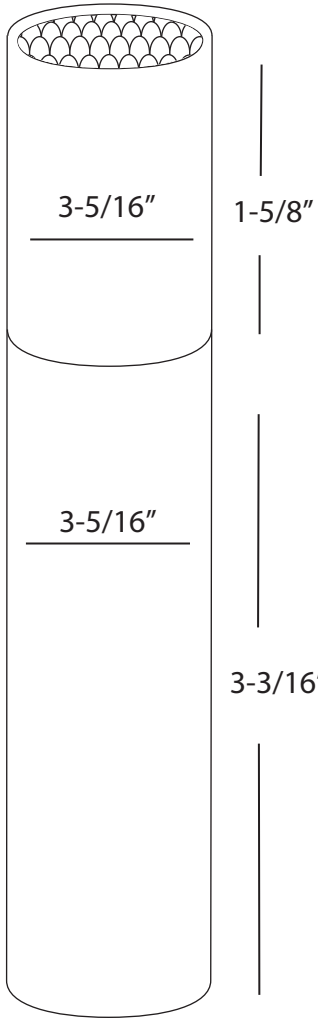

2" Standard Pouch

11 Sticks

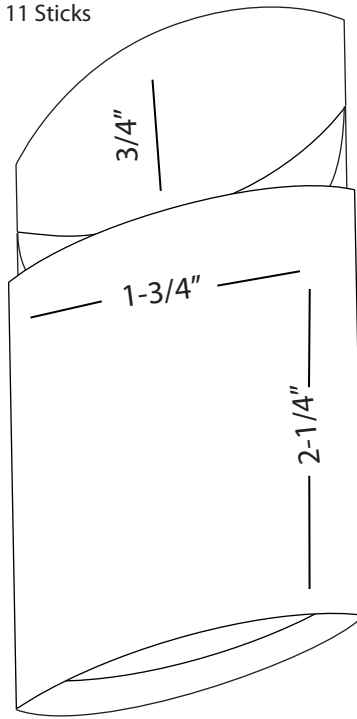

2" Larger Pouch

20 Sticks

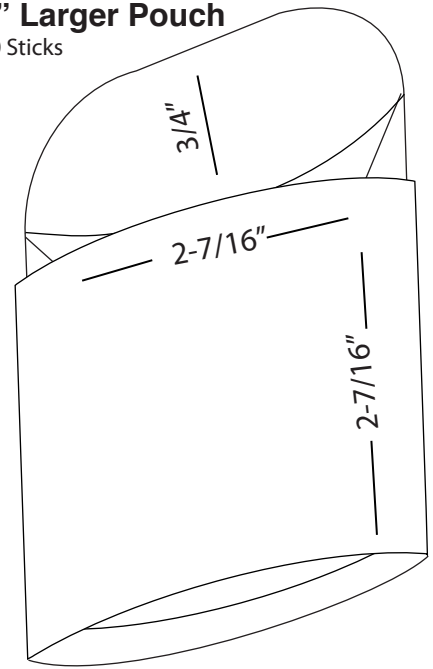

2" Drum Cylinder

24 sticks

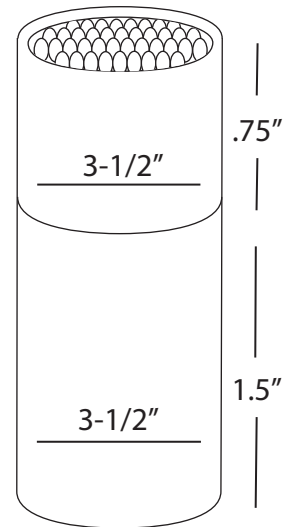

2" Flip Top

30 Sticks

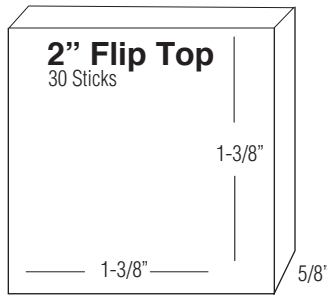

4" Tent

40 Sticks

2" Tent Double Drawer

135 sticks

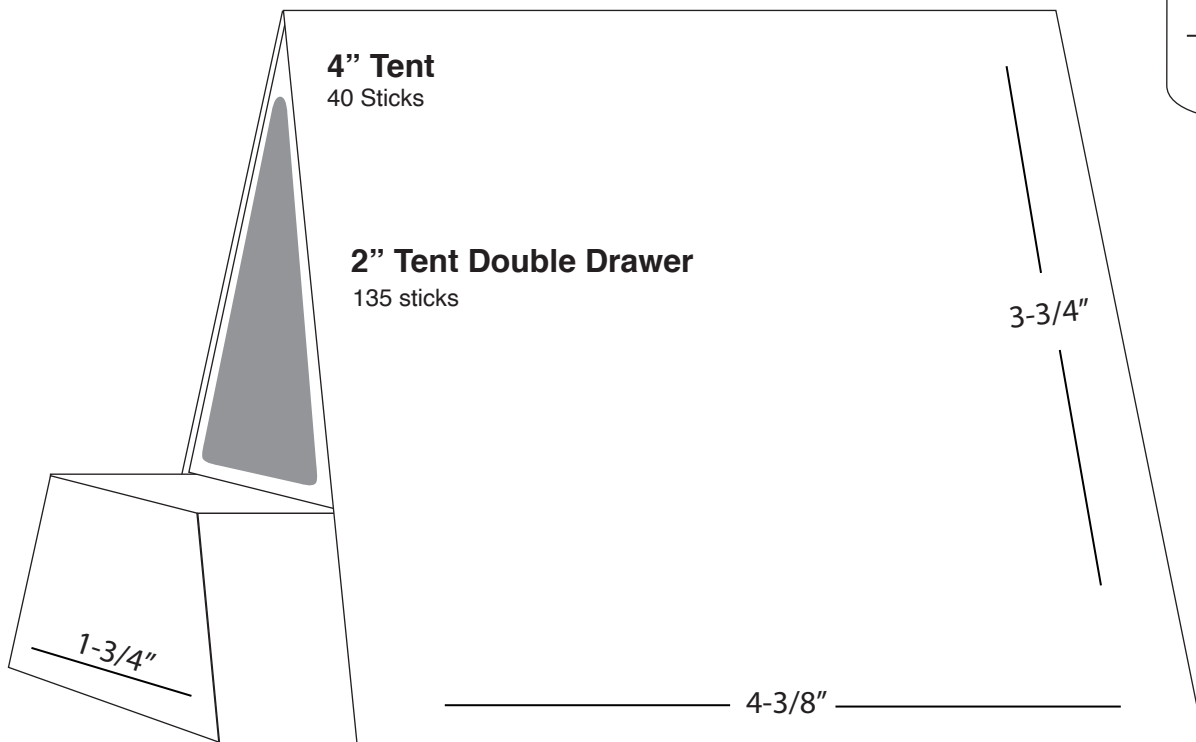

Specialty Match Boxes - Pricing

Art and plate charges will be assessed on all first time orders. Please allow 9 - 12 weeks for delivery. Expedited airfreight is available. 17 tip colors available on all standard boxes. Call for pricing on speciality options.

2" Fliptop	5,000	10,000	25,000	50,000
1 color Price per unit	1,795.00 \$0.36	\$2,700.00 \$0.27	\$4,600.00 \$0.23	\$6,270.00 \$0.21
2 color Price per unit	1,915.00 \$0.38	\$2,870.00 \$0.29	\$4,800.00 \$0.24	\$6,480.00 \$0.22
3 color Price per unit	2,035.00 \$0.41	\$3,060.00 \$0.31	\$5,020.00 \$0.25	\$6,690.00 \$0.22
4 color Price per unit	2,155.00 \$0.43	\$3,330.00 \$0.33	\$5,180.00 \$0.26	\$6,960.00 \$0.23

2" Standard Pouch	5,000	10,000	20,000	30,000	50,000
1 color Price per unit	\$1,845.00 \$0.37	\$3,330.00 \$0.33	\$6,320.00 \$0.32	\$6,840.00 \$0.23	\$10,750.00 \$0.22
2 color Price per unit	\$1,955.00 \$0.39	\$3,500.00 \$0.35	\$6,520.00 \$0.33	\$7,050.00 \$0.24	\$10,750.00 \$0.22
3 color Price per unit	\$2,070.00 \$0.41	\$3,660.00 \$0.41	\$6,700.00 \$0.34	\$7,260.00 \$0.24	\$11,000.00 \$0.22
4 color Price per unit	\$2,170.00 \$0.43	\$3,830.00 \$0.38	\$6,860.00 \$0.34	\$7,470.00 \$0.25	\$11,350.00 \$0.23

2" Larger Pouch	5,000	10,000	20,000	30,000	50,000
1 color Price per unit	\$2,935.00 \$0.59	\$5,250.00 \$0.53	\$10,020.00 \$0.50	\$13,560.00 \$0.45	\$19,300.00 \$0.39
2 color Price per unit	\$3,045.00 \$0.61	\$5,430.00 \$0.54	\$10,240.00 \$0.51	\$13,740.00 \$0.46	\$19,650.00 \$0.39
3 color Price per unit	\$3,150.00 \$0.63	\$5,580.00 \$0.56	\$10,400.00 \$0.52	\$13,950.00 \$0.47	\$19,900.00 \$0.40
4 color Price per unit	\$3,260.00 \$0.65	\$5,750.00 \$0.58	\$10,580.00 \$0.53	\$14,160.00 \$0.47	\$20,250.00 \$0.41

Specialty Boxes - Pricing

2" Drum	2,500	5,000	10,000	25,000	50,000	100,000
1 color Per Unit Price	\$1,802.50 \$0.72	\$2,395.00 \$0.48	\$4,330.00 \$0.43	\$8,625.00 \$0.35	\$15,000.00 \$0.30	\$28,700.00 \$0.28
2 colors Per Unit Price	\$1,982.50 \$0.79	\$2,635.00 \$0.53	\$4,570.00 \$0.46	\$9,150.00 \$0.37	\$15,900.00 \$0.32	\$29,700.00 \$0.29
3 colors Per Unit Price	\$2,160.00 \$0.86	\$2,866.00 \$0.57	\$4,820.00 \$0.48	\$9,650.00 \$0.39	\$16,650.00 \$0.33	\$30,900.00 \$0.31
4 color process Per Unit Price	\$2,340.00 \$0.94	\$3,105.00 \$0.62	\$5,060.00 \$0.51	\$10,175.00 \$0.41	\$17,400.00 \$0.35	\$31,900.00 \$0.31

4" Drum	1,000	2,500	5,000	10,000
1 color Price per unit	\$1,876.00 \$1.87	\$4,193.00 \$1.67	\$7,855.00 \$1.57	\$13,130.00 \$1.31
2 color Price per unit	\$1,966.00 \$1.96	\$4,340.00 \$1.73	\$8,095.00 \$1.61	\$13,580.00 \$1.35
3 color Price per unit	\$2,055.00 \$2.05	\$4,490.00 \$1.79	\$8,345.00 \$1.66	\$14,040.00 \$0.48
4 color Price per unit	\$2,142.00 \$2.14	\$4,635.00 \$1.85	\$8,590.00 \$1.71	\$14,490.00 \$1.44

2" Table Tent	1,000	2,500	5,000	10,000
1 color Price per unit	\$1,372.00 \$1.37	\$3,115.00 \$1.25	\$5,680.00 \$1.14	\$10,610.00 \$1.06
2 color Price per unit	\$1,473.00 \$1.47	\$3,322.00 \$1.33	\$5,895.00 \$1.18	\$10,870.00 \$1.09
3 color Price per unit	\$1,573.00 \$1.57	\$3,527.00 \$1.41	\$6,110.00 \$1.22	\$11,110.00 \$1.11
4 color Price per unit	\$1,674.00 \$1.67	\$3,730.00 \$1.49	\$6,325.00 \$1.27	\$11,360.00 \$1.14

4" Tent	1,000	2,500	5,000	10,000
1 color Per Unit Price	\$1,509.00 \$1.51	\$3,430.00 \$1.37	\$6,250.00 \$1.25	\$11,670.00 \$1.17
2 colors Per Unit Price	\$1,620.00 \$1.62	\$3,655.00 \$1.46	\$6,490.00 \$1.30	\$11,950.00 \$1.20
3 colors Per Unit Price	\$1,730.00 \$1.73	\$3,880.00 \$1.55	\$6,725.00 \$1.35	\$12,230.00 \$1.22
4 color process Per Unit Price	\$1,840.00 \$1.84	\$4,105.00 \$1.64	\$6,960.00 \$1.39	\$12,500.00 \$1.25

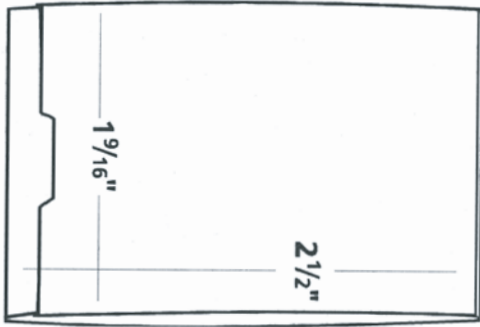

10 Pick Toothpick Booklet

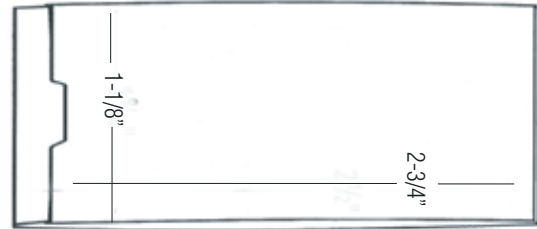

7 Pick Toothpick Booklet



Toothpick Box 10 count
2-3/4" x 1", 2 Sides: 2-3/4" x 5/16"



Toothpick Box 20 count
2-3/4" x 1", 2 Sides: 2-3/4" x 5/16"

Toothpick Specialty Options Pricing

Art and plate charges will be assessed on all first time orders. Please allow 9 - 12 weeks for delivery. Affordable expedited airfreight offered, please call for more details.

Specialty Options	2,500	5,000	10,000	25,000	50,000
Matte Varnish Cost Per Order	\$0.06 \$155.00	\$0.04 \$205.00	\$0.02 \$240.00	\$0.02 \$375.00	\$0.01 \$510.00
Spot Gloss Per Unit Price	\$0.03 \$80.00	\$0.02 \$105.00	\$0.01 \$115.00	\$0.01 \$190.00	\$0.01 \$250.00
Foil Hot Stamp Per Unit Price	\$0.06 \$145.00	\$0.06 \$275.00	\$0.06 \$550.00	\$0.05 \$1,370.00	\$0.05 \$2,740.00
Die Emboss Per Unit Price	\$0.04 \$95.00	\$0.04 \$190.00	\$0.04 \$380.00	\$0.04 \$940.00	\$0.04 \$1,880.00
Kraft Board Per Unit Price	\$0.01 \$25.00	\$0.01 \$50.00	\$0.01 \$100.00	\$0.01 \$250.00	\$0.01 \$500.00

Toothpick Pricing

Art and plate charges will be assessed on all first time orders. Please allow 9 - 12 weeks for delivery. Expedited airfreight is available.

Toothpick Booklet -10	2,500	5,000	10,000	25,000	50,000
1 color Per Unit Price	\$650.00 \$0.26	\$960.00 \$0.19	\$1,740.00 \$0.17	\$3,230.00 \$0.13	\$5,270.00 \$0.11
2 colors Per Unit Price	\$750.00 \$0.30	\$1,070.00 \$0.21	\$1,870.00 \$0.19	\$3,410.00 \$0.14	\$5,500.00 \$0.11
3 colors Per Unit Price	\$850.00 \$0.34	\$1,180.00 \$0.24	\$2,000.00 \$0.20	\$3,590.00 \$0.14	\$5,730.00 \$0.11
4 color process Per Unit Price	\$950.00 \$0.38	\$1,290.00 \$0.26	\$2,130.00 \$0.21	\$3,770.00 \$0.15	\$5,960.00 \$0.12

Toothpick Booklet -7		5,000	10,000	25,000	50,000
1 color Per Unit Price		\$625.00 \$0.13	\$1,080.00 \$0.11	\$2,335.00 \$0.09	\$3,850.00 \$0.08
2 colors Per Unit Price		\$735.00 \$0.15	\$1,200.00 \$0.12	\$2,525.00 \$0.10	\$4,070.00 \$0.08
3 colors Per Unit Price		\$845.00 \$0.17	\$1,320.00 \$0.13	\$2,715.00 \$0.11	\$4,300.00 \$0.09
4 color process Per Unit Price		\$955.00 \$0.19	\$1,440.00 \$0.14	\$2,905.00 \$0.12	\$4,530.00 \$0.09

Toothpick Box 20 count	2,500	5,000	10,000	25,000	50,000
1 color Per Unit Price	\$850.00 \$0.34	\$1,230.00 \$0.25	\$2,170.00 \$0.22	\$4,800.00 \$0.19	\$8,460.00 \$0.17
2 colors Per Unit Price	\$920.00 \$0.37	\$1,330.00 \$0.27	\$2,290.00 \$0.23	\$4,980.00 \$0.20	\$8,690.00 \$0.17
3 colors Per Unit Price	\$990.00 \$0.40	\$1,430.00 \$0.29	\$2,410.00 \$0.24	\$5,160.00 \$0.21	\$8,920.00 \$0.18
4 color process Per Unit Price	\$1,060.00 \$0.42	\$1,530.00 \$0.31	\$2,530.00 \$0.25	\$5,340.00 \$0.21	\$9,150.00 \$0.18

Toothpick Box 10 count	2,500	5,000	10,000	25,000	50,000
1 color Per Unit Price	\$700.00 \$0.28	\$980.00 \$0.20	\$1,510.00 \$0.15	\$3,400.00 \$0.14	\$6,080.00 \$0.12
2 colors Per Unit Price	\$770.00 \$0.31	\$1,080.00 \$0.20	\$1,630.00 \$0.16	\$3,580.00 \$0.14	\$6,300.00 \$0.13
3 colors Per Unit Price	\$840.00 \$0.34	\$1,180.00 \$0.24	\$1,750.00 \$0.18	\$3,740.00 \$0.15	\$6,520.00 \$0.13
4 color process Per Unit Price	\$910.00 \$0.36	\$1,280.00 \$0.26	\$1,870.00 \$0.19	\$3,920.00 \$0.16	\$6,740.00 \$0.13

Pulp Board Coaster Pricing

Call or email for pricing on Low Quantity Quick Ship Drink Coasters

3.5" 35 - 40 Point One Sided Print	2,500	5,000	10,000	15,000	25,000	50,000	Blank 1,000
One Side CMYK order cost	\$795.00	\$1,035.00	\$2,015.00	\$2,930.00	\$3,820.00	\$6,730.00	\$100.00
Cost per coaster	0.32	0.21	0.20	0.20	0.15	0.13	\$0.10
Die cut order cost	\$1,235.00	\$1,615.00	\$2,915.00	\$3,475.00	\$5,440.00	\$9,960.00	
Additional Die cut coaster cost	0.18	0.12	0.09	0.04	0.06	0.06	

3.5" 35 - 40 Point Two Sided Print	2,500	5,000	10,000	15,000	25,000	50,000
Two Side CMYK order cost	\$870.00	\$1,140.00	\$2,215.00	\$3,220.00	\$4,200.00	\$7,400.00
Cost per coaster	0.35	0.23	0.22	0.21	0.17	0.15
Die cut order cost	\$1,310.00	\$1,720.00	\$3,115.00	\$3,765.00	\$5,820.00	\$10,630.00
Additional Die cut coaster cost	0.18	0.12	0.09	0.04	0.06	0.06

4" 35 - 40 Point One Sided Print	2,500	5,000	10,000	15,000	25,000	50,000	Blank 1,000
One Side CMYK order cost	\$870.00	\$1,140.00	\$2,215.00	\$3,220.00	\$4,200.00	\$7,400.00	\$110.00
Cost per coaster	0.27	0.18	0.17	0.17	0.13	0.12	.011
Die cut order cost	\$1,310.00	\$1,720.00	\$3,115.00	\$3,765.00	\$5,820.00	\$10,630.00	
Additional Die cut coaster cost	0.18	0.12	0.09	0.04	0.06	0.06	

4" 35 - 40 Point Two Sided Print	2,500	5,000	10,000	15,000	25,000	50,000
Two Side CMYK order cost	\$950.00	\$1,245.00	\$2,215.00	\$3,220.00	\$4,590.00	\$8,070.00
Cost per coaster	0.38	0.22	0.21	0.18	0.18	0.16
Die cut order cost	\$1,390.00	\$1,825.00	\$3,115.00	\$3,765.00	\$6,210.00	\$11,300.00
Additional Die cut coaster cost	0.18	0.12	0.09	0.04	0.06	0.06

3.5" 50 - 60 Point One Sided Print	2,500	5,000	10,000	15,000	25,000	50,000	Blank 1,000
One Side CMYK order cost	\$840.00	\$1,100.00	\$2,140.00	\$3,110.00	\$4,060.00	\$7,155.00	\$120.00
Cost per coaster	0.34	0.22	0.21	0.21	0.16	0.12	0.12
Die cut order cost	\$1,285.00	\$1,680.00	\$2,555.00	\$4,320.00	\$5,675.00	\$10,380.00	
Additional Die cut coaster cost	0.18	0.12	0.09	0.08	0.06	0.06	

3.5" 50 - 60 Point Two Sided Print	2,500	5,000	10,000	15,000	25,000	50,000
Two Side CMYK order cost	\$930.00	\$1,210.00	\$2,350.00	\$3,420.00	\$4,060.00	\$7,870.00
Cost per coaster	0.37	0.24	0.24	0.23	0.16	0.16
Die cut order cost	\$1,375.00	\$1,790.00	\$3,250.00	\$4,630.00	\$5,675.00	\$11,095.00
Additional Die cut coaster cost	0.18	0.12	0.09	0.08	0.06	0.06

Pulp Board Coaster Pricing

Call or email for pricing on Low Quantity Quick Ship Drink Coasters

4" 50 - 60 Point One Sided Print	2,500	5,000	10,000	15,000	25,000	50,000	Blank 1,000
One Side CMYK order cost	\$930.00	\$1,210.00	\$2,350.00	\$3,4205.00	\$4,060.00	\$7,870.00	\$130.00
Cost per coaster	0.37	0.24	0.24	0.23	0.16	0.16	\$0.13
Die cut order cost	\$1,375.00	\$1,790.00	\$3,250.00	\$4,630.00	\$5,675.00	\$11,095.00	
Additional Die cut coaster cost	0.18	0.12	0.09	0.08	0.06	0.06	

4" 50 - 60 Point Two Sided Print	2,500	5,000	10,000	15,000	25,000	50,000
Two Side CMYK order cost	\$1,000.00	\$1,320.00	\$2,565.00	\$3,730.00	\$4,870.00	\$8,582.00
Cost per coaster	0.40	0.26	0.26	0.25	0.19	0.17
Die cut order cost	\$1,445.00	\$1,900.00	\$3,465.00	\$4,940.00	\$6,485.00	\$11,807.00
Additional Die cut coaster cost	0.18	0.12	0.09	0.08	0.06	0.06

3.5" 80 Point One Sided Print	2,500	5,000	10,000	15,000	25,000	50,000	Blank 1,000
One Side CMYK order cost	\$1,000.00	\$1,325.00	\$2,620.00	\$3,890.00	\$5,720.00	\$10,075.00	\$140.00
Cost per coaster	0.40	0.27	0.26	0.26	0.23	0.20	\$0.14
Die cut order cost	\$1,455.00	\$1,900.00	\$3,520.00	\$5,100.00	\$7,335.00	\$13,300.00	
Additional Die cut coaster cost	0.18	0.12	0.09	0.08	0.06	0.06	

3.5" 80 Point Two Sided Print	2,500	5,000	10,000	15,000	25,000	50,000
Two Side CMYK order cost	\$1,100.00	\$1,455.00	\$2,880.00	\$4,280.00	\$6,290.00	\$11,080.00
Cost per coaster	0.44	0.29	0.29	0.29	0.25	0.22
Die cut order cost	\$1,555.00	\$2,030.00	\$3,780.00	\$5,490.00	\$7,905.00	\$14,305.00
Additional Die cut coaster cost	0.18	0.12	0.09	0.08	0.06	0.06

4" 80 Point One Sided Print	2,500	5,000	10,000	15,000	25,000	50,000	Blank 1,000
One Side CMYK order cost	\$1,100.00	\$1,455.00	\$2,880.00	\$4,280.00	\$6,290.00	\$11,080.00	\$150.00
Cost per coaster	0.44	0.29	0.29	0.29	0.25	0.22	\$0.15
Die cut order cost	\$1,555.00	\$2,030.00	\$3,780.00	\$5,490.00	\$7,905.00	\$14,305.00	
Additional Die cut coaster cost	0.18	0.12	0.09	0.08	0.06	0.06	

4" 80 Point Two Sided Print	2,500	5,000	10,000	15,000	25,000	50,000
Two Side CMYK order cost	\$1,200.00	\$1,590.00	\$3,140.00	\$4,670.00	\$6,860.00	\$12,086.00
Cost per coaster	0.48	0.32	0.31	0.31	0.27	0.24
Die cut order cost	\$1,655.00	\$2,165.00	\$4,040.00	\$5,880.00	\$8,475.00	\$15,311.00
Additional Die cut coaster cost	0.18	0.12	0.09	0.08	0.06	0.06

Cellulose Coaster Pricing

Call for pricing on Embossed Tissue Coasters

3-3/8" Round Multi-Ply Cellulose	10,000	20,000	30,000	50,000
1 Color	\$1,320.00	\$1,760.00	\$2,345.00	\$3,080.00
Cost Per Coaster	\$0.13	\$0.09	\$0.08	\$0.06
2 Colors	\$1,385.00	\$1,850.00	\$2,455.00	\$3,260.00
Cost Per Coaster	\$0.14	\$0.09	\$0.08	\$0.07
3 Colors	\$1,450.00	\$1,940.00	\$2,565.00	\$3,440.00
Cost Per Coaster	\$0.15	\$0.10	\$0.09	\$0.07
4 Colors	\$1,515.00	\$2,030.00	\$2,675.00	\$3,620.00
Cost Per Coaster	\$0.15	\$0.10	\$0.09	\$0.07
Foil Hot Stamp	\$920.00	\$1,840.00	\$2,760.00	\$4,600.00
Full Bleed (up to 3.5")	\$250.00	\$500.00	\$750.00	\$1,250.00

\$150 plate fee per color/ foil plate \$230

4" Round Multi-Ply Cellulose	10,000	20,000	30,000	50,000
1 Color	\$1,375.00	\$1,965.00	\$2,705.00	\$3,600.00
Cost Per Coaster	\$0.14	\$0.10	\$0.09	\$0.07
2 Colors	\$1,445.00	\$2,070.00	\$2,855.00	\$3,780.00
Cost Per Coaster	\$0.14	\$0.10	\$0.10	\$0.08
3 Colors	\$1,515.00	\$2,175.00	\$3,005.00	\$3,960.00
Cost Per Coaster	\$0.15	\$0.11	\$0.10	\$0.08
4 Colors	\$1,585.00	\$2,280.00	\$3,155.00	\$4,140.00
Cost Per Coaster	\$0.16	\$0.11	\$0.11	\$0.08
Foil Hot Stamp	\$920.00	\$1,840.00	\$2,760.00	\$4,600.00

\$150 plate fee per color/ foil plate \$230

Different Die-Cut Edges may be available: Please Inquire: Straight edge, Small scalloped, Large Scalloped

Printing Limitations: Due to the flexible and absorbent cellulose tissue material, with 2-color printing separate plate registration of at least 1.5mm (about 1/16") is necessary. There may be slight color variations from the selected Pantone-U ink colors. Screens, heavy ink coverage, colors abutting, and full bleed print are not allowed.

Soft Embossed Tissue Coaster Pricing

7-Ply 4.25" Square Tissue	10,000	20,000	30,000	50,000
1 Color	\$1,470.00	\$2,110.00	\$2,900.00	\$3,885.00
Cost Per Coaster	\$0.15	\$0.11	\$0.10	\$0.08
2 Colors	\$1,550.00	\$2,220.00	\$3,060.00	\$4,085.00
Cost Per Coaster	\$0.16	\$0.11	\$0.10	\$0.08
3 Colors	\$1,630.00	\$2,330.00	\$3,220.00	\$4,285.00
Cost Per Coaster	\$0.16	\$0.12	\$0.11	\$0.09
4 Colors	\$1,710.00	\$2,440.00	\$3,380.00	\$4,485.00
Cost Per Coaster	\$0.17	\$0.12	\$0.11	\$0.09
Foil Hot Stamp	\$920.00	\$1,840.00	\$2,760.00	\$4,600.00
Full Bleed (up to 3.5")	\$250.00	\$500.00	\$750.00	\$1,250.00

\$150 plate fee per color/ foil plate \$230

7-Ply 4" Round Tissue	10,000	20,000	30,000	50,000
1 Color	\$1,380.00	\$1,970.00	\$2,710.00	\$3,600.00
Cost Per Coaster	\$0.14	\$0.10	\$0.09	\$0.07
2 Colors	\$1,450.00	\$2,070.00	\$2,850.00	\$3,780.00
Cost Per Coaster	\$0.15	\$0.10	\$0.10	\$0.08
3 Colors	\$1,520.00	\$2,170.00	\$2,990.00	\$3,960.00
Cost Per Coaster	\$0.15	\$0.11	\$0.10	\$0.08
4 Colors	\$1,590.00	\$2,270.00	\$3,130.00	\$4,140.00
Cost Per Coaster	\$0.16	\$0.11	\$0.11	\$0.08
Foil Hot Stamp	\$920.00	\$1,840.00	\$2,760.00	\$4,600.00

\$150 plate fee per color/ foil plate \$230

Soft Embossed Tissue Coaster Pricing

7-Ply 3.5" Round Tissue	10,000	20,000	30,000	50,000
1 Color	\$1,340.00	\$1,900.00	\$2,610.00	\$3,450.00
Cost Per Coaster	\$0.13	\$0.10	\$0.09	\$0.07
2 Colors	\$1,410.00	\$1,995.00	\$2,750.00	\$3,630.00
Cost Per Coaster	\$0.14	\$0.10	\$0.09	\$0.07
3 Colors	\$1,480.00	\$2,090.00	\$2,890.00	\$3,810.00
Cost Per Coaster	\$0.15	\$0.10	\$0.10	\$0.08
4 Colors	\$1,550.00	\$2,185.00	\$3,030.00	\$3,990.00
Cost Per Coaster	\$0.16	\$0.11	\$0.10	\$0.08
Foil Hot Stamp	\$920.00	\$1,840.00	\$2,760.00	\$4,600.00

\$150 plate fee per color/ foil plate \$230

7-Ply 5.5" Round Tissue	10,000	20,000	30,000	50,000
1 Color	\$1,900.00	\$3,200.00	\$4,470.00	\$6,400.00
Cost Per Coaster	\$0.19	\$0.16	\$0.15	\$0.13
2 Colors	\$2,000.00	\$3,320.00	\$4,700.00	\$6,720.00
Cost Per Coaster	\$0.20	\$0.17	\$0.16	\$0.13
Foil Hot Stamp	\$920.00	\$1,840.00	\$2,760.00	\$4,600.00

\$920.00 \$1,840.00 \$2,760.00 \$4,600.00

\$150 plate fee per color/ foil plate \$230